

Assembly and installation instructions

BlueNet PDU

BN3000/3500/5000/7000/7500

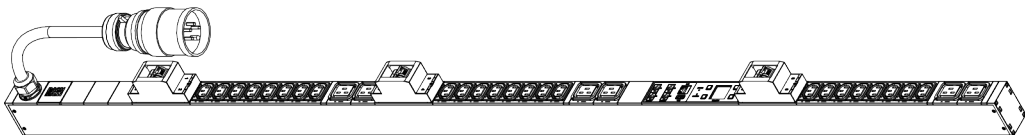
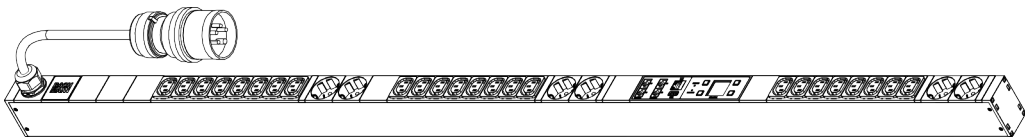

BlueNet

**BACH
MANN**

Read the instructions prior to performing any task!

Bachmann GmbH
Ernstaldenstraße 33
70565 Stuttgart
Germany
Telephone: +49 711 86602-0 Fax:
+49 711 86602-34
email: bluenet@bachmann.com
Internet: www.bachmann.com

Bach-30131-DE, 5, en_GB

About the assembly and installation instructions

These instructions facilitate the safe and efficient assembly and installation of the BlueNet power distribution unit (hereinafter called "PDU"). These instructions constitute an integral part of the PDU and must be retained. If the PDU is transferred to a third party, these instructions must also be transferred with the PDU.

Persons who are entrusted to work on the PDU must have carefully read and understood these instructions prior to starting any work. Compliance with all the safety information and instructions set out in these instructions is an essential prerequisite for safe operation.

The illustrations in these instructions are provided for purposes of basic understanding and can deviate from the actual version.

Copyright

The contents of these instructions are protected by copyright. Their use is permitted in conjunction with the assembly and installation of the PDU. Any use that exceeds this is not permitted, unless the written approval of Bachmann GmbH has been obtained.

Software licenses

The software contains components that are protected by copyright and are licensed in terms of various license models. A copy of the terms of the licenses is included with the PDU as of software version V1.01.XX and can be accessed via the web interface for the PDU. With older software versions, a copy of the license texts can be requested by sending an email to bluenet@bachmann.com.

Other applicable documents

In addition to these instructions, the following additional documents apply:

- Operating instructions
- Data sheet
- Safety information

Customer service

Telephone: +800 222 46 266

email: service@bsg-bachmann.com

Table of contents

1	Overview	5
	1.1 Overview of the PDU.....	5
	1.2 Short description.....	8
	1.3 Displays and controls.....	8
	1.4 Communication.....	11
	1.5 Scope of delivery.....	12
	1.6 Optional accessories.....	12
2	Explanation of symbols	13
3	Personnel requirements and responsibilities	14
4	Unpacking the PDU	15
5	Installing and connecting the PDU	16
	5.1 Safety instructions for the installation.....	16
	5.2 Requirements of the installation location.....	16
	5.3 Installing the PDU.....	16
	5.3.1 Overview.....	16
	5.3.2 Installing the PDU with the mounting brackets.....	18
	5.3.3 Installation with plug-in brackets via the rear of the PDU.....	19
	5.3.4 Installation with plug-in brackets via the sides of the PDU.....	20
	5.3.5 Installation with the mounting solution in the rack... ..	21
	5.4 Connecting the PDU to the power supply.....	23
	5.5 Connecting the network cable.....	23
	5.6 Connecting the sensors.....	24
	5.7 Cascading the PDUs.....	24
6	Putting the PDU into operation	27
	6.1 Adjusting the display orientation.....	27
	6.2 Querying the network address of the PDU.....	28
	6.3 Configuring the PDU via the web interface (software version V1.00.XX).....	29
	6.4 Configuring the PDU via the web interface (as of software version V1.01.XX).....	34
7	Operation	39
8	Troubleshooting	40
9	Cleaning the PDU	41
10	Dismantling and disposing of the PDU	42
	10.1 Dismantling.....	42
	10.2 Disposal.....	42
11	Technical specifications	43
12	Index	44

1 Overview

1.1 Overview of the PDU

Overview of functions

Functions	Measurement per phase	Measurement per socket	Identification	Switching
Product name				
BN3000	x	–	–	–
BN3500	x	x	x	–
BN5000	–	–	x	x
BN7000	x	–	x	x
BN7500	x	x	x	x

Example of a 16-amp version

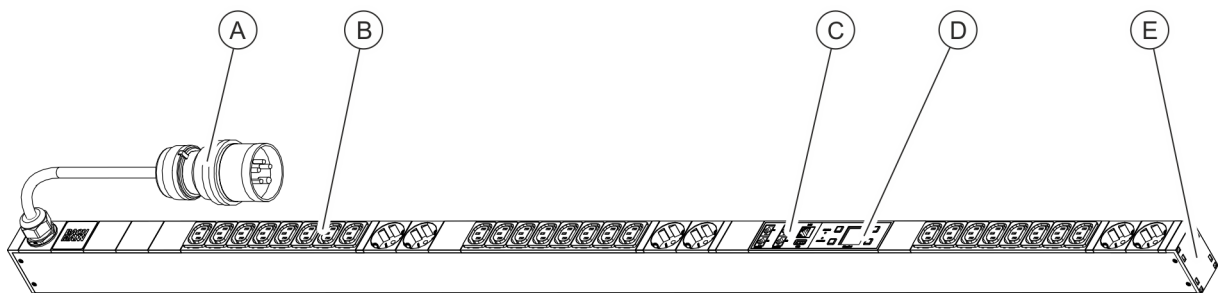

Fig. 1: Product overview (16 amp version)

- (A) CEE connector plug
- (B) Sockets
- (C) Connector panel for network, Modbus and sensors
- (D) Control panel
- (E) Fitting slots for plug-in bracket

Example of a 32-amp version

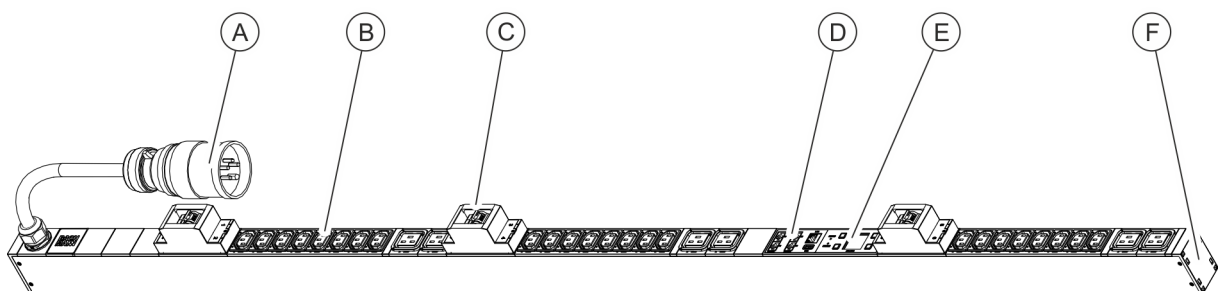
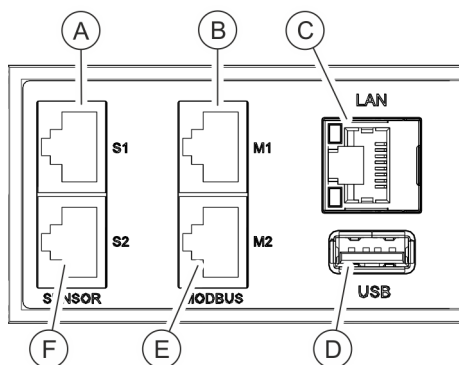

Fig. 2: Product overview (32 amp version)

- (A) CEE connector plug
- (B) Sockets
- (C) Circuit breaker / automatic fuse
- (D) Connector panel for network, Modbus and sensors
- (E) Control panel
- (F) Fitting slots for plug-in bracket

Connector panel for a master PDU



- (A) Sensor port S1 (to connect a sensor via a cat 5e cable)
- (B) Modbus port M1 (to connect a slave PDU via a cat 5e cable)
- (C) LAN port
- (D) USB port
- (E) Port M2 (for connecting future applications)
- (F) Sensor port S2 (to connect a sensor via a cat 5e cable)

Fig. 3: Connector panel (master PDU)

Connector panel for a slave PDU

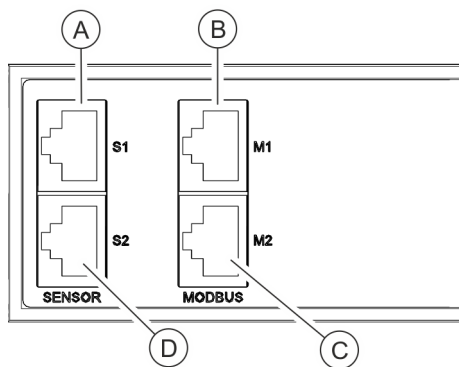

- (A) Sensor port S1 (to connect a sensor via a cat 5e cable)
- (B) Modbus port M1 (to connect a master PDU and upstream slave PDUs via a cat 5e cable)
- (C) Modbus port M2 (to connect a slave PDU via a cat 5e cable)
- (D) Sensor port S2 (to connect a sensor via a cat 5e cable)

Fig. 4: Connector panel (slave PDU)

Control panel

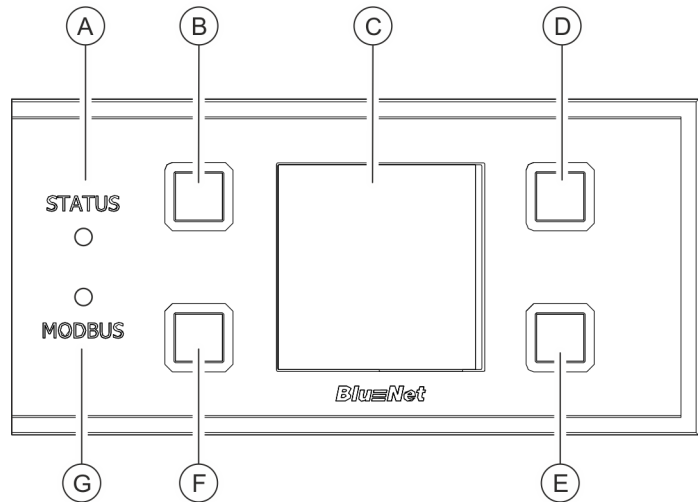

Fig. 5: Control panel

- Ⓐ Status LED
- Ⓑ Operating button 1
- Ⓒ Display
- Ⓓ Operating button 2
- Ⓔ Operating button 3
- Ⓕ Operating button 4
- Ⓖ Modbus LED

Fitting options on the back

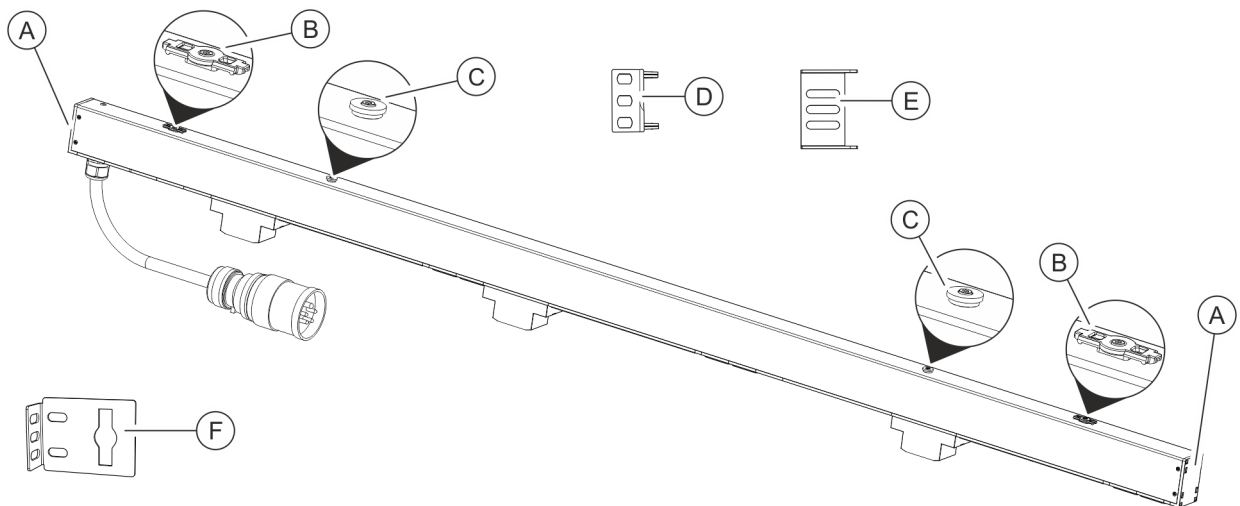

Fig. 6: Overview of the fitting options for the PDU

- Ⓐ Fitting slots for plug-in bracket
- Ⓑ Attachment for the mounting bracket
- Ⓒ Attachment for the mounting solution in the rack
- Ⓓ Plug-in bracket for mounting the PDU via the back (2 each)
- Ⓔ Plug-in bracket for mounting the PDU via the sides (2 each)
- Ⓕ Mounting bracket (x 2)

1.2 Short description

The power supply of a data centre can be monitored and controlled remotely via the PDU. The PDU can be set up for single-phase or three-phase systems. The individual phases can be distinguished by their colours. The PDU is supplied with electricity via a CEE plug.

The current, power (active, apparent and reactive power), power consumption, voltage and frequency of all phases are monitored via the PDU. This enables the efficient planning of resources and the issuing of an alarm in the event of a fault. The PDU is designed for a power range of 3.6 to 22 kW.

The PDU is integrated into the company network via the LAN port (only available on the master PDU). Up to 10 slave PDUs can be cascaded with a master PDU via the Modbus port.

The PDU can be operated locally via the display, via SNMP access or with a web browser over a network, and the HTTP, HTTPS, SSH, SNMP and Modbus-TCP protocols can be used.

The PDU is made of a sturdy aluminium profile and is installed directly into the rack.

Depending on the type, the PDU has a variety of features such as safety-plug sockets or IEC320 C14 and C20 type non-heating appliance connectors, and external sensors (temperature/humidity).

A connector inserted into the PDU can be secured with the non-heating appliance locking device (C13/C19).

1.3 Displays and controls

Display with control keys

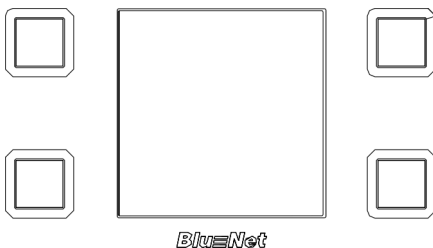
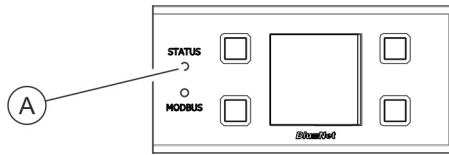

Fig. 7: Display with control keys

The PDU can be operated locally via the display using the control keys:

- Display system data (hardware and software version, serial number, MAC address and item no.)
- Display the measured data
- Set the duration and orientation of the display
- Display and adjust the network settings as well as enabling or disabling the DHCP protocol

Master PDU status LED



The status LED displays the status of the PDU. Possible states are:

Fig. 8: Status LED

Colour	Light	Status
Green	Continuously green	All measurements are OK and the status of the individual loads and sensors are OK
Orange	Continuously orange	The measurement monitor is issuing a warning (based on all the measurements of the master PDUs and sensors)
Red	Continuously red	The measurement monitor is issuing an alarm (based on all the measurements of the master PDUs and sensors) or the signal to a slave PDU or a sensor has been interrupted
Yellow	Continuously yellow	PDU is starting up
White	Continuously white	Light signal to release the pressed key (during Factory Reset)
Purple	500 ms off, 500 ms purple	An update of a PDU is being carried out
Purple, red	500 ms off, 500 ms purple, 500 ms off, 500 ms red	An error occurred during the update of a PDU

Slave PDU status LED

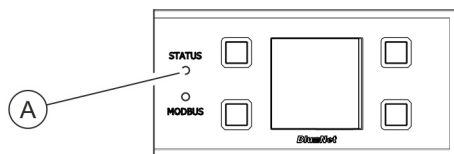

The status LED displays the status of the PDU. Possible states are:

Fig. 9: Slave PDU status LED

Starting process

Colour	Light	Status
Blue, orange	900 ms blue, 100 ms orange	Connection to master PDU not yet established or lost
Green	Continuously green	Connection to master PDU present
Blue, purple	500 ms blue, 500 ms purple	An update of a PDU is being carried out
Blue, purple, red	500 ms blue, 500 ms purple, 500 ms blue, 500 ms red	An error occurred during the update of a PDU

In operation

Colour	Light	Status
Orange	900 ms off, 100 ms orange	Connection to master PDU not yet established or lost
Green, red	500 ms off, 100 ms green, 500 ms off, 100 ms red	Connection to master PDU present, internal communication problems have occurred
Green	900 ms off, 100 ms green	Connection to master PDU present, internal communication functioning
Purple	500 ms off, 500 ms purple	An update of the internal modules of a PDU is being carried out
Purple, red	500 ms off, 500 ms purple, 500 ms off, 500 ms red	Error during update of the internal modules of a PDU
Red	Continuously red	Measurement monitoring is issuing an alarm
Orange	Continuously orange	The measurement monitor is issuing a warning

Modbus LED

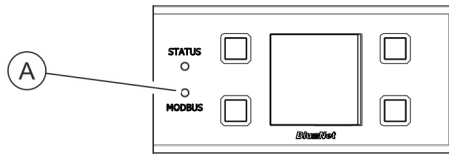

Fig. 10: Modbus LED

The Modbus LED displays the activity of the PDUs connected to the Modbus.

If the connection between the master and slave PDU is lost, the Modbus LED on the master PDU goes out and the Modbus LED on the slave PDU flashes.

**Status LED on the sockets
(only on BN3500/5000/7000/7500)**

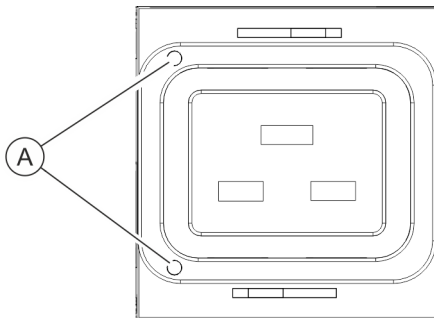

Fig. 11: Status LEDs on the sockets

The status LEDs (only available on the BN3500/5000/7000/7500) display the status of the loads connected to the sockets.

i See the operating instructions for further information about the status LEDs on the sockets.

1.4 Communication

Connection for sensors S1/S2

A temperature sensor and a humidity sensor can be connected to the PDU via the ports for sensors. The values can be called up under 'Status → External sensors' in the web interface.

M1/M2 port for Modbus

Several PDUs can be connected to each other via the Modbus port. This way, up to 10 slave PDUs can be cascaded with a master PDU and managed via the web interface. The slave PDU is connected to the master PDU via the M1 Modbus port. Further slave PDUs are connected to each other via the M1/M2 Modbus ports of the particular slave PDU.

LAN port (10/100 Mbit/s)

The PDU can be integrated into the network via the LAN port. The data transfer rate is controlled via the network.

**USB port for firmware updates
(only on the master PDU)**

There is a USB port on the PDU next to the display and control panel. This is for updating the firmware.

1.5 Scope of delivery

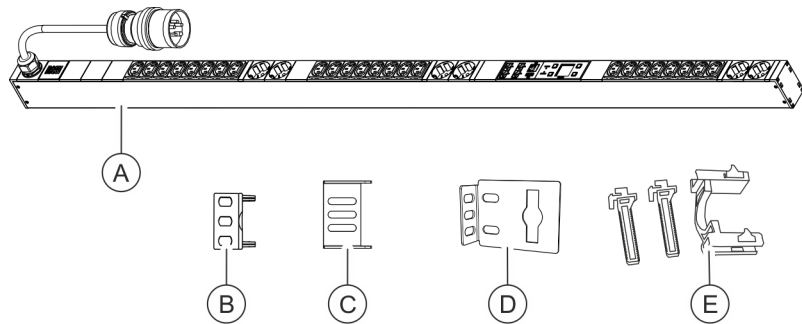

Fig. 12: Scope of delivery

The scope of the delivery includes:

- PDU (Fig. 12/A)
- Two plug-in brackets for mounting the PDU via the back (Fig. 12/B)
- Two plug-in brackets for mounting the PDU via the sides (Fig. 12/C)
- Two mounting brackets (Fig. 12/D)
- Two sets of non-heating appliance locking devices (C13/C19) (Fig. 12/E)



The plug-in bracket for mounting the PDU via the sides is included in the delivery as of August 2015.

1.6 Optional accessories

Temperature sensor and humidity sensor

The temperature and humidity at the installation location of the PDU can be measured via a temperature sensor and a humidity sensor. The values can be displayed in the display and on the web interface. The cat 5e cable required to connect the sensors is included.

2 Explanation of symbols

Safety information

Safety information is indicated by symbols in these instructions. The safety information is introduced by signal words that express the nature of the danger.



DANGER!

This combination of symbol and signal word indicates that there is an imminent danger that will result in death or serious injury if it is not avoided.



WARNING!

This combination of symbol and signal word indicates that there is a potential danger that can result in death or serious injury if it is not avoided.



NOTICE!





This combination of symbol and signal word indicates that there is a potential danger that can result in damage to property if it is not avoided.

Tips and recommendations



This symbol highlights useful tips and recommendations as well as information for efficient and trouble-free operation.

The following markings are used to highlight specific instructions, results, lists, references and other elements in these instructions:

Marking	Explanation
	Step-by-step instructions
	Results of the steps of an instruction
	References to sections in these instructions and to other applicable documents
	Items in a list without a specified sequence

3 Personnel requirements and responsibilities

**WARNING!****Risk of injury if the personnel is insufficiently qualified!**

If unqualified personnel carry out the installation work on the PDU, serious injuries or substantial damage to property can be caused.

- The installation and the connection of the PDU must be carried out by an IT specialist.
- Defective components on the PDU must be repaired by a qualified electrician.

Only permit persons to work on the PDU who can be expected to carry out their work reliably. Persons whose capacity to react is impaired, e.g. through drugs, alcohol, or medication, cannot be permitted to perform such work.

In these instructions, the following personnel qualifications are required for the various tasks listed below:

IT specialist

IT specialists have obtained specialist training or the appropriate experience in dealing with IT systems and have a basic knowledge of electrical engineering.

Due to their specialist training, IT specialists are in a position to assess the consequences of their actions in dealing with the system as well as its components and the potential dangers in respect thereof and are able to avoid these.

The duties of an IT specialist include the following tasks:

- Setting up hardware and software systems
- Installing updates
- Maintenance work on the PDU
- Administration of the PDU via the web interface
- System diagnostics

Qualified electrician

Due to their professional training, knowledge and experience, as well as their knowledge of the relevant standards and regulations, qualified electricians are capable of working on electrical installations and independently identify and avoid potential dangers.

Qualified electricians are specifically trained for the working environment in which they work and know the relevant standards and regulations.

4 Unpacking the PDU

Unpacking

- Unpack the delivery and check its completeness and integrity. If there is a defect, contact Bachmann GmbH immediately.
- If possible, keep the packaging of the PDU so that the PDU can be safely stored and transferred in the future. Dispose of the packaging material that is no longer required in a manner that is environmentally responsible.

5 Installing and connecting the PDU

5.1 Safety instructions for the installation

Improper installation

**NOTICE!****Risk of damage due to improper fitting and installation!**

Improper fitting and installation can cause substantial damage to property.

- All the installation work must be carried out by an IT specialist.
- Only install the PDU while it is de-energised.
- Before starting the work, ensure that you have sufficient room for the installation.
- Ensure that installation area is clean and tidy.
- Install the components properly and lay the connectors and cables in a manner that is safe.
- Secure the components so that they cannot fall down or over.

5.2 Requirements of the installation location

- There must be enough space in the rack to install the PDU.
- The PDU may only be operated within the environmental conditions set out in the technical specifications.
- The PDU may not be used in potentially explosive atmospheres.
- The PDU may not be subjected to vibrations.
- A location for the installation must be selected that does not have excessive humidity, high temperatures, sources of electromagnetic interference, moisture, solvents, flammable gases, dust or vapours.
- There must be sufficient lighting.
- Fire protection measures must be in place.

5.3 Installing the PDU

5.3.1 Overview

Overview of the fitting options for the PDU

There are four options for installing the PDU in the rack:

- Installation with mounting brackets (↪ *Chapter 5.3.2 'Installing the PDU with the mounting brackets' on page 18*)
- Installation with plug-in brackets via the rear of the PDU (↪ *Chapter 5.3.3 'Installation with plug-in brackets via the rear of the PDU' on page 19*)

- Installation with plug-in brackets via the sides of the PDU (↪ Chapter 5.3.4 'Installation with plug-in brackets via the sides of the PDU' on page 20)
- Installation with the mounting solution in the rack (↪ Chapter 5.3.5 'Installation with the mounting solution in the rack' on page 21)

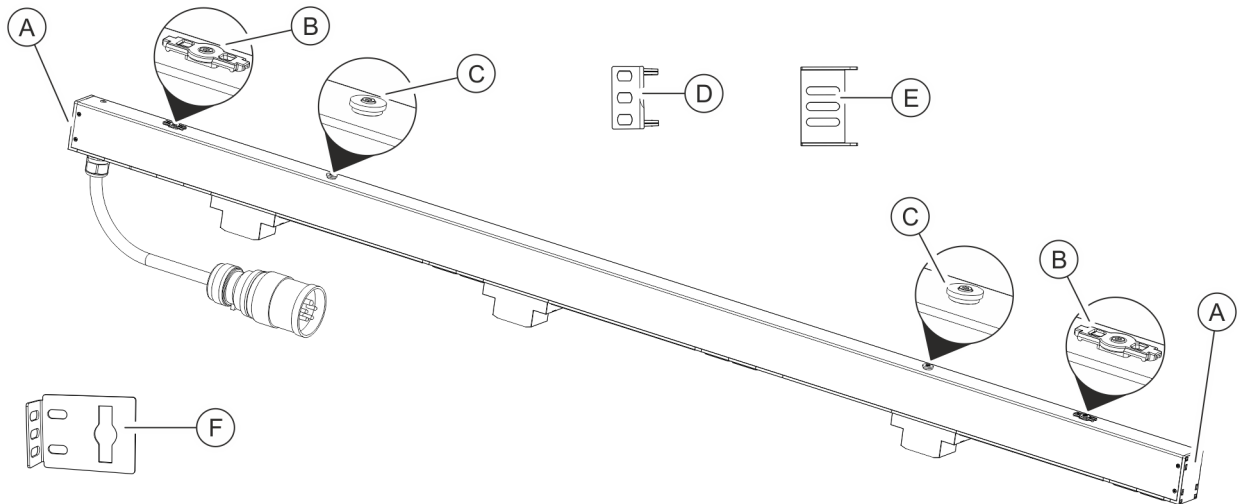

Fig. 13: Overview of the fitting options for the PDU

- | | |
|--|---|
| <ul style="list-style-type: none"> Ⓐ Fitting slots for plug-in bracket Ⓑ Attachment for the mounting bracket Ⓒ Attachment for the mounting solution in the rack | <ul style="list-style-type: none"> Ⓓ Plug-in brackets for mounting the PDU via the back Ⓔ Plug-in brackets for mounting the PDU via the sides Ⓕ Mounting bracket |
|--|---|

Tools required

The following tools are required for the installation:

- Phillips screwdriver
- Torx screwdriver (IP8)

5.3.2 Installing the PDU with the mounting brackets

Personnel: IT specialist

1. ➤ Fit the mounting brackets (Fig. 14/Ⓐ) onto the attachments at the top and bottom of the PDU (Fig. 14/Ⓑ).
2. ➤ Hold the PDU in the desired position against the rack and mark the position of the mounting holes.

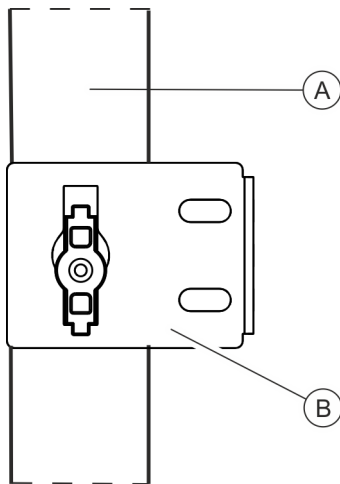

Fig. 14: Installation with mounting brackets

- Ⓐ PDU
- Ⓑ Mounting bracket

3. ➤ Remove the mounting brackets (Fig. 15/Ⓐ) from the PDU and screw them onto the rack in the positions marked.

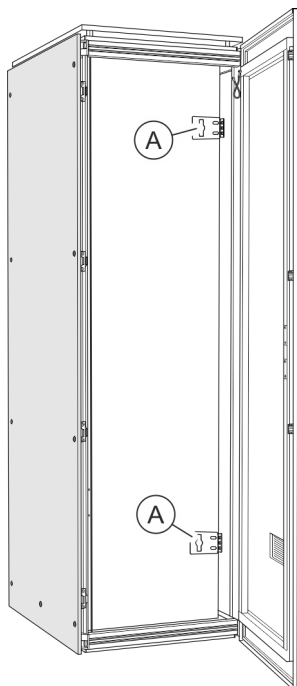

Fig. 15: Rack with mounting brackets

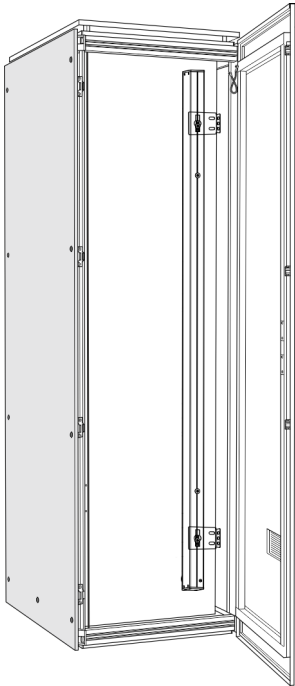

Fig. 16: Rack with PDU

4. ➔ Fit the PDU onto the mounting brackets (Fig. 16).

5.3.3 Installation with plug-in brackets via the rear of the PDU

Personnel: ■ IT specialist

1. ➔ Insert the plug-in brackets into the rear slots on both sides (Fig. 17).
2. ➔ Position the PDU in the rack.

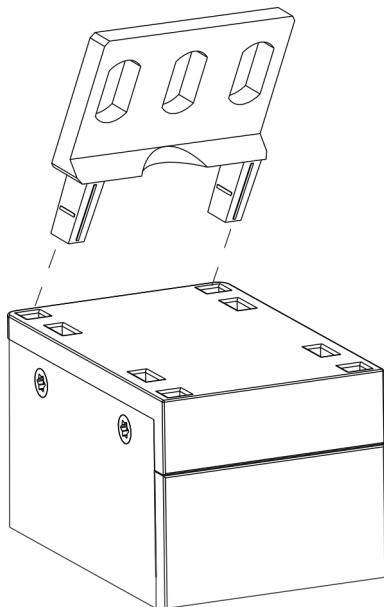
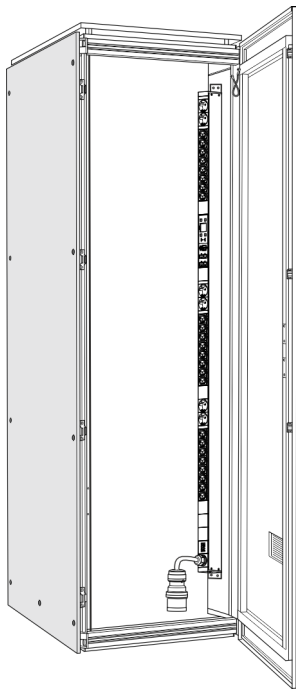

Fig. 17: Fitting the plug-in brackets

Installing the PDU > Installation with plug-in brackets via the sides of the PDU



3. ➤ Fasten the PDU to the rack with screws via both plug-in brackets (Fig. 20).

Fig. 18: Rack with PDU

5.3.4 Installation with plug-in brackets via the sides of the PDU

Personnel: ■ IT specialist

1. ➤ Insert the plug-in brackets into the side slots on both sides (Fig. 19).
2. ➤ Position the PDU in the rack.

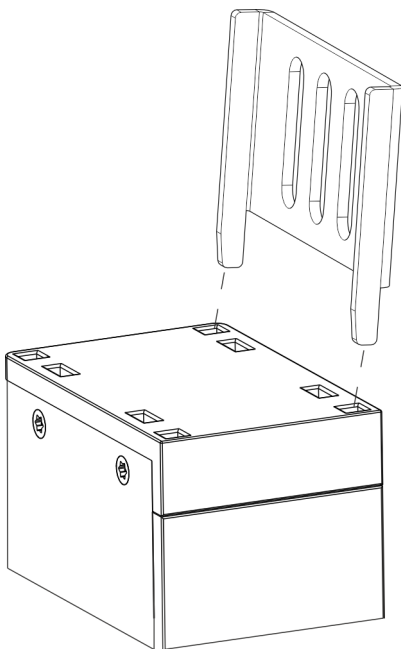
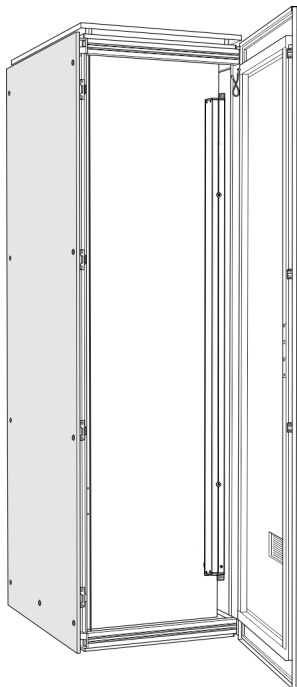

Fig. 19: Fitting the plug-in brackets



3. ➔ Fasten the PDU to the rack with screws via both plug-in brackets (Fig. 20).

Fig. 20: Rack with PDU

5.3.5 Installation with the mounting solution in the rack

Personnel: ■ IT specialist

1. ➔ Unscrew the attachment for the mounting bracket with a screwdriver (Fig. 21/Ⓐ).

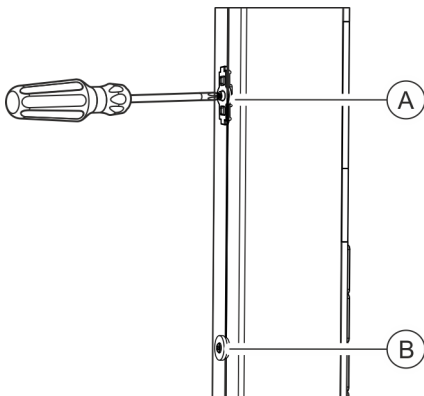
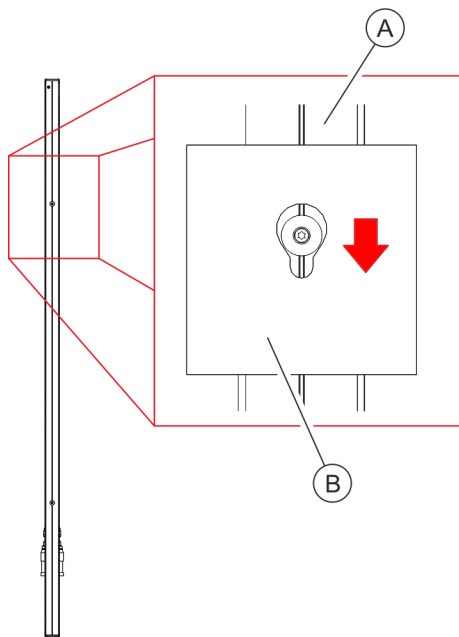

Fig. 21: Unscrewing the attachment for the mounting bracket

- Ⓐ Attachment for the mounting bracket
- Ⓑ Attachment for the mounting solution in the rack

Installing the PDU > Installation with the mounting solution in the rack



2. Fit the PDU into the provided fitting slots via the attachment for the existing mounting solution in the rack (Fig. 22).

Fig. 22: Fitting the PDU in the rack with mounting solution

- (A) PDU
- (B) Mounting solution in the rack (example)

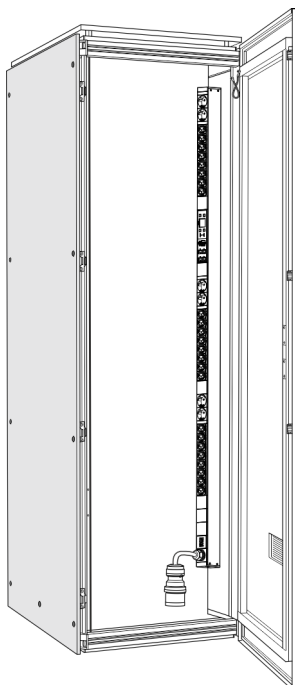

3. Check that the PDU is fitted securely into the cabinet.

Fig. 23: Rack with PDU

5.4 Connecting the PDU to the power supply

Electric current



WARNING!

Risk of fatal injury due to electric current!

If live components are touched, there is an imminent risk of fatal injury due an electric shock. Damage to the insulation or the individual components can constitute a life-threatening danger.

- Always ensure that access to the power socket is unobstructed so that in the event of an emergency the power cable can be disconnected immediately.
- Do not touch the PDU or its connecting line if either of these is damaged. Disconnect the current from the relevant power socket (e.g. via the relevant circuit breaker) and then carefully unplug the power cable from the power socket. Do not continue using the PDU, but have it repaired by qualified electrician.
- In order to disconnect the PDU from the mains completely, unplug its power cable from the power socket.
- Do not touch the power cable plug with wet hands.
- When unplugging the power cable plug from the power socket, always pull the plug and not the cable. Do not pull the cable to unplug the power cable plug.
- The power cable must not be crushed, kinked, damaged by sharp edges or subjected to any other mechanical stress.
- Avoid subjecting the power cable to excessive heat or cold.

Connecting the power connection

Personnel: ■ IT specialist

1. ➤ Insert the CEE plug of the PDU into the CEE socket.
2. ➤ Connect the CEE plug to the power supply.

5.5 Connecting the network cable

Personnel: ■ IT specialist

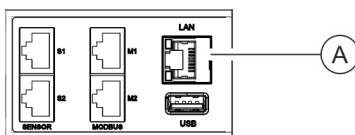

Fig. 24: LAN port

1. ➤ Insert the connector of the data cable into the LAN port on the master PDU (Fig. 24/A).
2. ➤ Properly lay the data cable to the network splitter.
3. ➤ Insert the data cable into the network splitter.

5.6 Connecting the sensors

Connecting the sensor for measuring the temperature

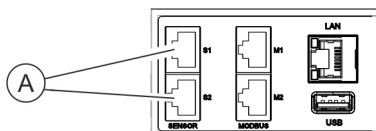

Fig. 25: Sensor port S1/S2

Connecting the sensor for measuring the humidity

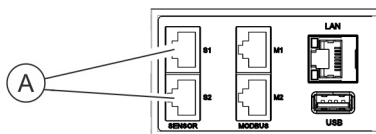

Fig. 26: Sensor port S1/S2

5.7 Cascading the PDUs

Wiring



The sensor used for the ambient temperature must be an original sensor from Bachmann GmbH to guarantee communication with the software.

Personnel: ■ IT specialist

➔ Insert the connector of the ambient temperature sensor into port S1 or S2 on the PDU (Fig. 25/A).



The combined humidity and temperature sensor used must be an original sensor from Bachmann GmbH to guarantee communication with the software.

Personnel: ■ IT specialist

➔ Insert the connector of the humidity sensor into port S1 or S2 on the PDU (Fig. 26/A).



Several PDUs can be connected to each other via the Modbus port. This way, up to 10 slave PDUs can be cascaded with a master PDU and managed via the web interface.

It is not possible to connect individual PDUs with a crossover cable.

Personnel: ■ IT specialist

1. ➔ Connect a cat 5e cable to the Modbus port M1 of the master PDU.
2. ➔ Connect a cat 5e cable to the Modbus port M1 of the slave PDU.
3. ➔ Connect further slave PDUs to each other via a network cable to the respective Modbus ports M1 and M2.

Setting the Modbus address on the slave PDU

1. ➤ Press any button on the slave PDU to activate the display.
2. ➤ Use the ⓘ key to open the “System” menu.

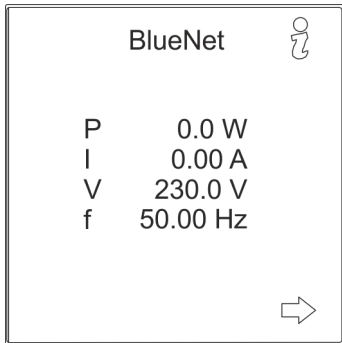

Fig. 27: “BlueNet” menu

3. ➤ Use the ⚙ key to open the “Settings” menu.

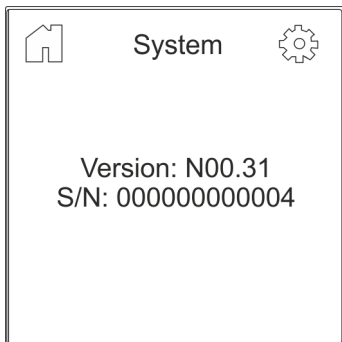

Fig. 28: “System” menu

4. ➤ Use the ⏴ key to select the “Modbus Config” menu and confirm by pressing the ✓ key.

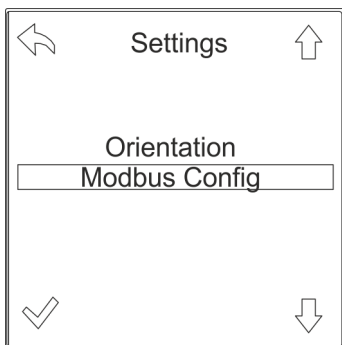
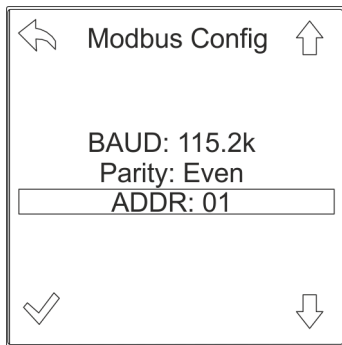



Fig. 29: “Settings” menu



5. Use the ↓ key to select the “ADDR” menu and confirm by pressing the ✓ key.

Fig. 30: “ADDR” menu



6.  *Valid Modbus addresses can be assigned from 1 to 16.*

If necessary, use the ⇐ key to switch between digits. Use the ↑ key to set the address for the slave PDU and confirm by pressing the ✓ key.

Fig. 31: Setting the Modbus address

6 Putting the PDU into operation

6.1 Adjusting the display orientation



The display orientation can be manually adjusted (0°, 90°, 180°, 270°) according to the installation position.

Personnel: IT specialist

1. ➔ Press any button on the PDU to activate the display.
2. ➔ Use the key to open the "System" menu.

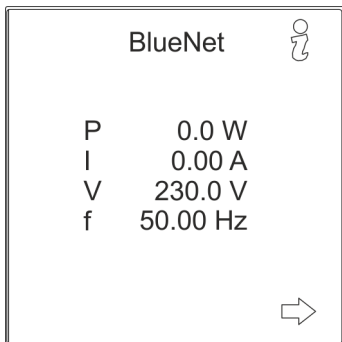

Fig. 32: "BlueNet" menu

3. ➔ Use the key to open the "Settings" menu.

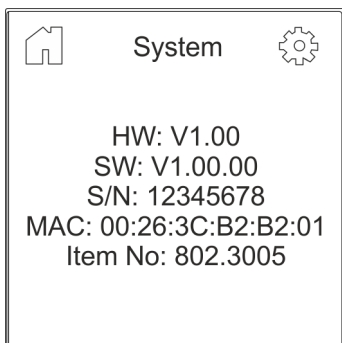

Fig. 33: "System" menu

4. ➔ Use the key to select the "Orientation" menu and confirm by pressing the key.

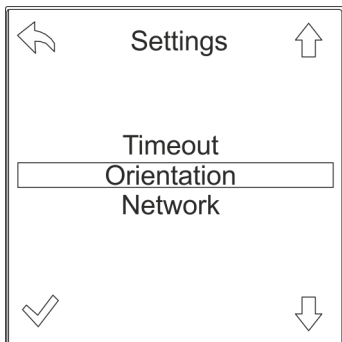

Fig. 34: "Settings" menu

Querying the network address of the PDU

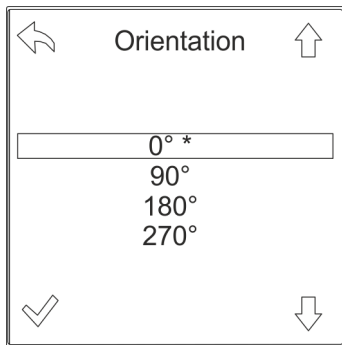

Fig. 35: "Orientation" menu

5. Use the \uparrow/\downarrow keys to select the desired display orientation and confirm by pressing the \checkmark key.
 - ⇒ The orientation of the display changes and the function of the individual keys changes accordingly.

6.2 Querying the network address of the PDU

The DHCP protocol is enabled by default. After connecting the power supply and the network connection, the PDU automatically obtains an IP address from the server.

Personnel: ■ IT specialist

1. Press any button on the PDU to activate the display.
2. Use the ? key to open the "System" menu.

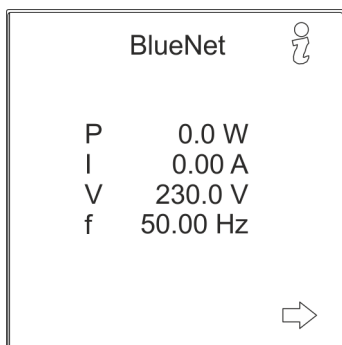

Fig. 36: "BlueNet" menu

3. Use the ⚙ key to open the "Settings" menu.

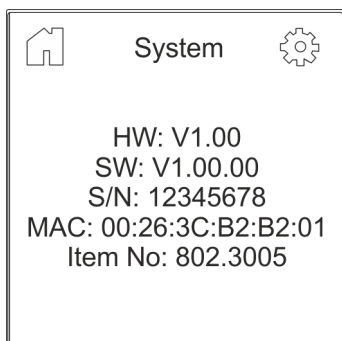

Fig. 37: "System" menu

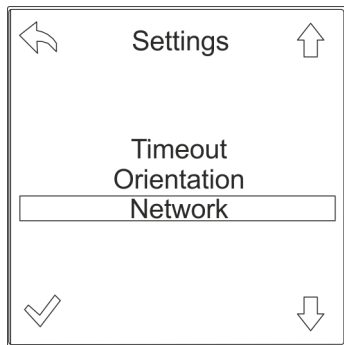

Fig. 38: "Settings" menu

4. Use the \downarrow key to select the "Network" menu and confirm by pressing the \checkmark key.

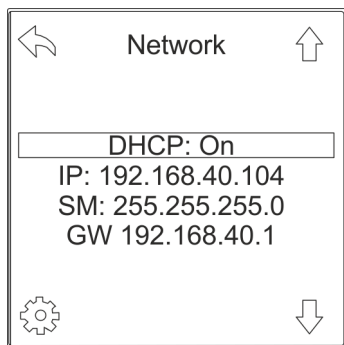

Fig. 39: "Network" menu

5. Make a note of the IP address displayed in the "Network" menu for subsequent entry in the web browser.



If there is no DHCP server in the network, the IP address has to be assigned manually. Consult the operating instructions to find the procedure for assigning the IP address manually.

6.3 Configuring the PDU via the web interface (software version V1.00.XX)



The PDU is configured for the web interface with the setup wizard.

In certain windows, the navigation buttons 'Skip' or 'Back' are available. The respective browser button to go back has no function in this application.



For a detailed description of the web interface, see [Chapter 7 'Operation'](#) on page 39.

Personnel: ■ IT specialist

1. Select the IP address of the PDU (<https://<IP address>>) in a web browser.
 - ⇒ The login information is requested.

Configuring the PDU via the web interface (software version V1.00.XX)

Logging in

Benutzer:
 Kennwort:

2. Log in with standard login.

i *User: admin*
Password: admin

Fig. 40: Login

Configuration ▾
 Network settings
 SMTP settings
 NTP settings
 SNMP settings
 Syslog settings
 System information
 System commands
 Filetransfer
Configuration wizard (A)

3. Choose 'Setup → Setup wizard' to start the setup wizard (Fig. 41/A).

⇒ The "BlueNet 2 Web UI" window opens (Fig. 42).

Fig. 41: Opening the setup wizard

BlueNet 2 Web UI
 PDU serial number: 12345678
 IP address: 192.168.40.104
 MAC address: 00:26:3C:B2:B2:01 (A)
 (B)

4.

i *The serial number, the IP address and MAC address of the PDU are displayed in this window. In the options menu, you can start the setup wizard (Fig. 42/A) or skip setup (Fig. 42/B).*

Fig. 42: "BlueNet 2 Web UI" window

Use the 'Start setup wizard' button (Fig. 42/A) to start the setup wizard.

⇒ The "Network settings" window opens.

i *The network settings can be set automatically via the DHCP protocol or entered manually in the setup wizard.*

Using the network settings via DHCP



Fig. 43: "Network settings" window

- 5. In the "Network settings" window, click the 'Use DHCP' button (Fig. 43/A).
 - ⇒ The "DHCP information" window opens.



Fig. 44: "DHCP information" window

- 6. In the DHCP information" window, click the 'Continue' button (Fig. 44/A).
 - ⇒ The "SNMP settings" window opens (see step 12).

Configuring the network settings manually

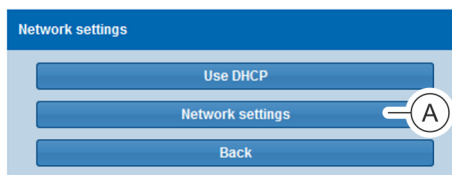

Fig. 45: "Network settings" window

- 7. In the "Network settings" window, click the 'Manual setup' button (Fig. 45/A).
 - ⇒ The "Network configuration" window opens.

Configuring the PDU via the web interface (software version V1.00.XX)

Fig. 46: “Network configuration” window

Configuring the SNMP settings

Fig. 47: “SNMP settings” window

8. In the ‘*DHCPv4*’ option menu (Fig. 46/Ⓐ) in the “Network configuration” window, select the “DHCP on” parameter.

Alternatively, select the “Manual” parameter in the option menu and manually enter the IPv4 address, IPv4 net mask and gateway.

9.



You can only select the “Prioritise DHCPv6” parameter if IPv6 is activated.

In the ‘*DNS*’ option menu (Fig. 46/Ⓑ) in the “Network configuration” window, select the “Prioritise DHCPv4” or “Prioritise DHCPv6” parameter.

Alternatively, select the “Manual” parameter and manually enter the primary DNS address and the secondary DNS addresses 1 and 2.

10. If required, click the ‘*Activate IPv6*’ checkbox (Fig. 46/Ⓒ) in the “Network configuration” window.

11. When the checkbox has been activated, select the “DHCP on” parameter in the ‘*DHCPv6*’ option menu (Fig. 46/Ⓓ).

Alternatively, select the “Manual” parameter and manually enter the IPv6 address, IPv6 prefix length and gateway.

12. Confirm the entries by clicking the ‘*Continue*’ button (Fig. 46/Ⓔ).

13. In the “SNMP settings” window, enter the location (Fig. 47/Ⓐ) and the contact (Fig. 47/Ⓑ).

14. If required, click the ‘*Activate SNMP V1/2*’ checkbox (Fig. 47/Ⓒ).

15. If required, click the ‘*Activate SNMP V3*’ checkbox (Fig. 47/Ⓓ).

16. If necessary, enter an SNMP Read Community or SNMP Write Community (Fig. 47/Ⓔ).

17. If necessary, click on the pencil icon (Fig. 47/Ⓕ) to set up the SNMP access control.

⇒ The “IP addresses” window opens (Fig. 48).

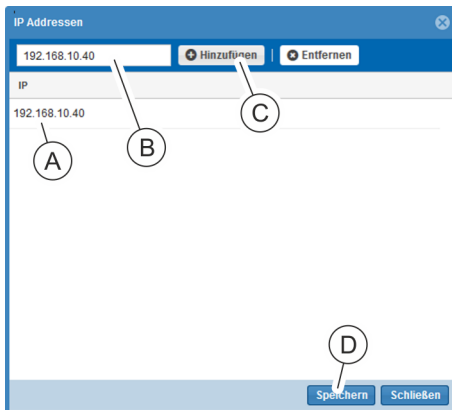

Fig. 48: "IP addresses" window

18. Enter an IP address in the text box (Fig. 48/ⓑ) and use the 'Add' button (Fig. 48/ⓒ) to add it to the list (Fig. 48/ⓐ).
19. After completing the entry, close the window using the 'Save' button (Fig. 48/ⓓ).
20. Confirm the entry by clicking the 'Continue' button (Fig. 47/ⓐ).

Configuring the SMTP settings

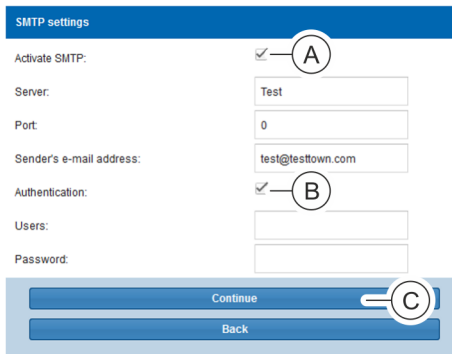

Fig. 49: "SMTP settings" window

21. If required, click the 'Activate SMTP' checkbox (Fig. 49/ⓐ) and enter a server address, a port and a sender's e-mail address.
22. If required, activate the 'Authentication' checkbox (Fig. 49/ⓑ) and define a user and password.
23. Confirm the entries by clicking the 'Continue' button (Fig. 49/ⓒ).

Configuring the NTP settings

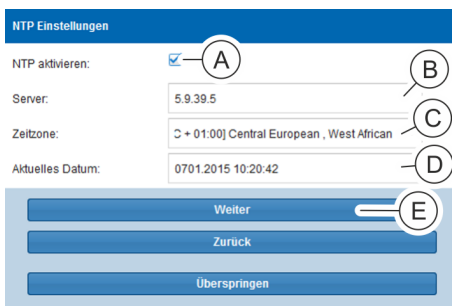

Fig. 50: "NTP settings" window

24. If required, click the 'Activate NTP' checkbox (Fig. 50/ⓐ), enter a server address (Fig. 50/ⓑ) and select a time zone (Fig. 50/ⓒ).
Alternatively, do not click the 'Activate NTP' checkbox (Fig. 50/ⓐ) and only enter the date and time (Fig. 50/ⓓ).
25. Confirm the entries by clicking the 'Continue' button (Fig. 50/ⓔ).

Completing the setup wizard

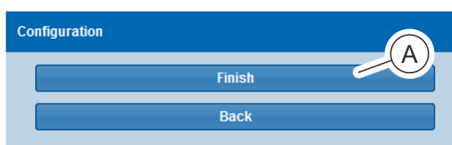

Fig. 51: "Setup" window

26. Use the 'Finish' button (Fig. 51/ⓐ) to close the setup wizard.

Configuring the PDU via the web interface (as of software version V1.01.XX)

6.4 Configuring the PDU via the web interface (as of software version V1.01.XX)

Personnel: IT specialist

1. Select the IP address of the PDU (https://<IP address>) in a web browser.
 - ⇒ The login information is requested.

Logging in

Fig. 52: Login

2. Log in with standard login.

i *User: admin*
Password: admin

- ⇒ If the web interface is started for the first time, the “BlueNet 2 Web UI” window is displayed.

Fig. 53: “BlueNet 2 Web UI” window

3. **i** *The serial number, the IP address and MAC address of the PDU are displayed in this window. In the options menu, you can start the setup wizard (Fig. 53/A) or skip setup (Fig. 53/B).*

Use the ‘Start setup wizard’ button (Fig. 53/A) to start the setup wizard.

- ⇒ The “Network settings” window opens.

i *The network settings can be set automatically via the DHCP protocol or entered manually in the setup wizard.*

Using the network settings via DHCP

Fig. 54: “Network settings” window

4. In the “Network settings” window, click the ‘Use DHCP’ button (Fig. 54/A).
 - ⇒ The “DHCP information” window opens.

Fig. 55: "DHCP information" window

5. In the "DHCP information" window, click the 'Continue' button (Fig. 55/A).
 ⇒ The "SNMP settings" window opens (see step 14).

Configuring the network settings manually

Fig. 56: "Network settings" window

6. In the "Network settings" window, click the 'Manual setup' button (Fig. 56/A).
 ⇒ The "Network settings" window opens.

Fig. 57: "Network settings" window

7. In the options menu in the "Network settings" window, activate the 'DHCPv4' checkbox in the 'IPv4' area (Fig. 57/A).
 Alternatively, do not activate the 'DHCPv4' checkbox and enter the IP address, subnet mask and gateway manually.

Configuring the PDU via the web interface (as of software version V1.01.XX)

8. ➔



You can only select the “Prioritise DHCPv6” parameter if IPv6 is activated.

In the ‘DNS’ option menu (Fig. 57/Ⓔ) in the “Network settings” window, select the “Prioritise DHCPv4” or “Prioritise DHCPv6” parameter.

Alternatively, select the “Manual” parameter and manually enter the primary DNS address and the secondary DNS addresses 1 and 2.

9. ➔

If required, click the ‘Activate IPv6’ checkbox in the ‘IPv6’ area (Fig. 57/Ⓒ) of the “Network settings” window.

10. ➔

If the ‘Activate IPv6’ checkbox is activated, activate the ‘DHCPv6’ checkbox (Fig. 57/Ⓔ) if necessary.

Alternatively, do not activate the ‘DHCPv6’ checkbox and enter the IPv6 address and IPv6 prefix length manually (Fig. 57/Ⓔ).

11. ➔

If necessary, enter a gateway in the ‘IPv6’ area (Fig. 57/Ⓔ).

12. ➔

If necessary, activate the ‘Stateless autoconfig’ checkbox in the ‘IPv6’ area (Fig. 57/Ⓔ).

13. ➔

Confirm the entries by clicking the ‘Continue’ button (Fig. 57/Ⓕ).

Configuring the SNMP settings

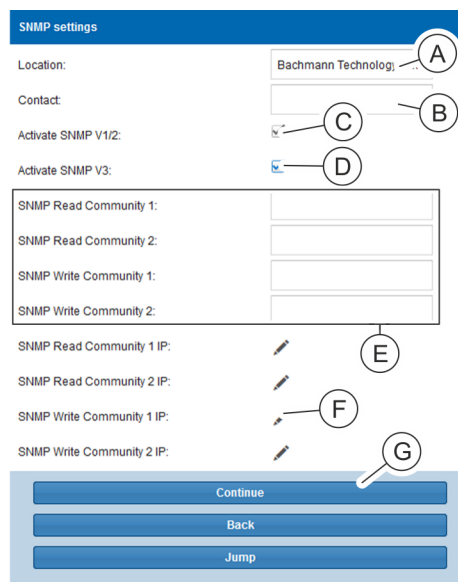

Fig. 58: “SNMP settings” window

14. ➔

In the “SNMP settings” window, enter the location (/Fig. 58/Ⓐ) and the contact (Fig. 58/Ⓑ).

15. ➔

If required, click the ‘Activate SNMP V1/2’ checkbox (Fig. 58/Ⓒ).

16. ➔

If required, click the ‘Activate SNMP V3’ checkbox (Fig. 58/Ⓓ).

17. ➔

If necessary, enter an SNMP Read Community or SNMP Write Community (Fig. 58/Ⓔ).

18. ➔

If necessary, click on the pencil icon (Fig. 58/Ⓕ) to set up the SNMP access control.

⇒ The “IP addresses” window opens (Fig. 59).

Configuring the PDU via the web interface (as of software version V1.01.XX)

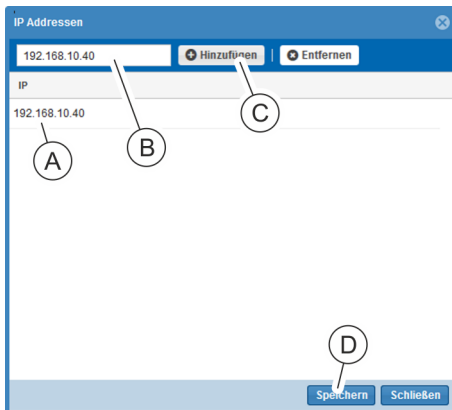

Fig. 59: "IP addresses" window

- 19. Enter an IP address in the text box (Fig. 59/ⓑ) and use the 'Add' button (Fig. 59/Ⓒ) to add it to the list (Fig. 59/Ⓐ).
- 20. After completing the entry, close the window using the 'Save' button (Fig. 59/ⓓ).
- 21. Confirm the entry by clicking the 'Continue' button (Fig. 58/Ⓒ).

Configuring the SMTP settings

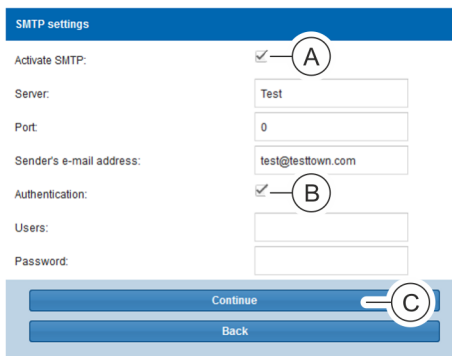

Fig. 60: "SMTP settings" window

- 22. If required, click the 'Activate SMTP' checkbox (Fig. 60/Ⓐ) and enter a server address, a port and a sender's e-mail address.
- 23. If required, activate the 'Authentication' checkbox (Fig. 60/Ⓑ) and define a user and password.
- 24. Confirm the entries by clicking the 'Continue' button (Fig. 60/Ⓒ).

Configuring the NTP settings

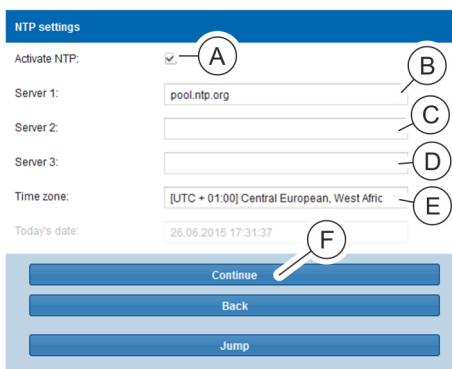
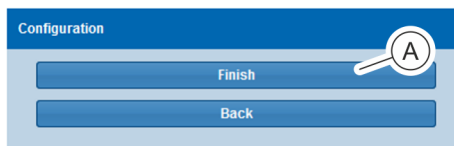

Fig. 61: "NTP settings" window

- 25. If required, click the 'Activate NTP' checkbox (Fig. 61/Ⓐ), enter a server address (Fig. 61/Ⓑ) in the 'Server 1' field and select a time zone (Fig. 61/Ⓒ). If necessary, enter additional server addresses in the 'Server 2' (Fig. 61/Ⓓ) and 'Server 3' (Fig. 61/Ⓔ) fields.
Alternatively, do not click the 'Activate NTP' checkbox (Fig. 61/Ⓐ) and only enter the date and time (Fig. 61/Ⓕ).
- 26. Confirm the entries by clicking the 'Continue' button (Fig. 61/Ⓒ).

Configuring the PDU via the web interface (as of software version V1.01.XX)

Completing the setup wizard



27. Use the 'Finish' button (Fig. 62/A) to close the setup wizard.

Fig. 62: "Setup" window

7 Operation



The operation of the web interface is described in the accompanying operating instructions.

The operating instructions can be downloaded from www.bachmann.com in the 'Downloads' area. Make sure to download the correct operating instructions for your software version of the PDU. You can read the software version on the PDU (→ 'Reading the software version' on page 39).

Reading the software version

Personnel: ■ IT specialist

1. → Press any button on the PDU to activate the display.
2. → Use the key to open the "System" menu.

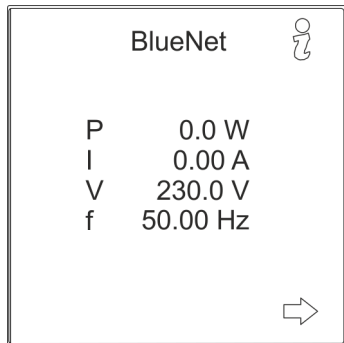

Fig. 63: "BlueNet" menu

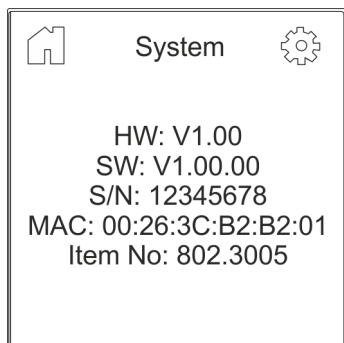

Fig. 64: "System" menu

3. → View 'SW:' to read the software version of the PDU.

8 Troubleshooting

Fault description	Cause	Remedy
No display.	The display is switched off.	<ul style="list-style-type: none"> ■ Press a button on the PDU to switch on the display.
	There is no voltage.	<ul style="list-style-type: none"> ■ Check the fuses (if any). ■ Connect the on-site power supply.
	The PDU is not connected correctly.	<ul style="list-style-type: none"> ■ Check the connections.
The status LED does not light up.	There is no voltage.	<ul style="list-style-type: none"> ■ Check the fuses (if any). ■ Connect the on-site power supply.
	The PDU is not connected correctly.	<ul style="list-style-type: none"> ■ Check the connections.
No current at one socket.	There is no voltage.	<ul style="list-style-type: none"> ■ Check the fuses (if any). ■ Connect the on-site power supply.

9 Cleaning the PDU

Electric current

**WARNING!****Risk of fatal injury due to electric current!**

Cleaning the unit whilst it is supplied with power is dangerous.

- Always unplug the power supply cable from the socket before cleaning.

Improper cleaning

**NOTICE!****Risk of damage to the PDU due to improper cleaning!**

Cleaning that is carried out improperly can damage the PDU.

- Do not use strong acids or bases for cleaning.
- Only clean the PDU with a lint-free cloth.
- Do not use a high-pressure cleaner or compressed air for cleaning. Keep splashing and sprayed water away from the PDU.

10 Dismantling and disposing of the PDU

10.1 Dismantling

Electric current

**WARNING!****Risk of fatal injury due to electric current!**

If there is contact with live devices, there is a risk of sustaining fatal injuries. Live electrical devices can cause extremely serious injuries.

- Before starting to dismantle, switch off the power supply and permanently disconnect it.

Dismantling the PDU

Personnel: ■ IT specialist

1. ▶ Disconnect the CEE plug from the power supply.
2. ▶ Unplug the power cable plug.
3. ▶ Unplug the plugs of the connected devices.
4. ▶ Dismantle the PDU from the rack.

10.2 Disposal



Electric and electronic components must not be disposed of with household waste.

If the service life of the PDU has expired, dispose of it according to the applicable local waste disposal regulations. Never use force to open the PDU.

Fig. 65: Do not dispose in household waste

11 Technical specifications

Specifications of the PDU



The technical specifications of the PDU are set out on the nameplate and the data sheet.

Nameplate

The nameplate is located on the housing of the PDU and contains the following information:

- Product name
- Part number
- Serial number
- MAC address (physical network address)
- Rated current
- Rated voltage
- Power frequency
- Manufacturer's address
- CE marking

12 Index

- A**
- Accessories 12
 - Attachment 7
- C**
- Cascading (master/slave PDU) 24
 - Cleaning 41
 - Communication 11
 - Connecting
 - Electric current 23
 - Network 23
 - Sensors 24
 - Connections
 - Modbus 11
 - Network 11
 - Sensors 11
 - USB 11
 - Connector panel 5, 6
 - Control keys 7, 8
 - Control panel 5
 - Copyright 3
 - Customer service 3
- D**
- Dismantling 42
 - Display 7, 8
 - Disposal 42
- E**
- Explanation of symbols 13
- F**
- Faults 40
- H**
- Humidity sensor 12
- I**
- Installation
 - Cascading the PDUs 24
 - Connecting the network cable 23
 - Connecting the power supply 23
 - Connecting the sensors 24
 - Overview 16
 - with plug-in brackets via the rear of the PDU 19
 - with plug-in brackets via the sides of the PDU 20
 - with the mounting bracket 18
 - with the mounting solution in the rack 21
 - Installation location 16
- L**
- Login 29
- M**
- Modbus LED 7, 11
 - Mounting bracket 7, 12, 16
- N**
- Nameplate 43
 - Network cable 23
 - Non-heating appliance locking device 12
- O**
- Operation 39
- P**
- Personnel 14
 - Plug-in bracket 7, 12, 16
 - Product overview 5
 - Putting into operation
 - Adjusting the display orientation 27
 - Configuring the PDU via the web interface 29
 - Querying the network address 28
- S**
- Scope of delivery 12
 - Service 3
 - Setup wizard 29
 - Short description 8
 - Socket LEDs 11
 - Socket types 5
 - Status LED 7, 9
- T**
- Technical specifications 43
 - Temperature sensor 12
 - Tools 17
- U**
- Unpacking 15
- W**
- Web interface 29